

PLAN

GATES - 12' LONG
 EXCEPT "A"

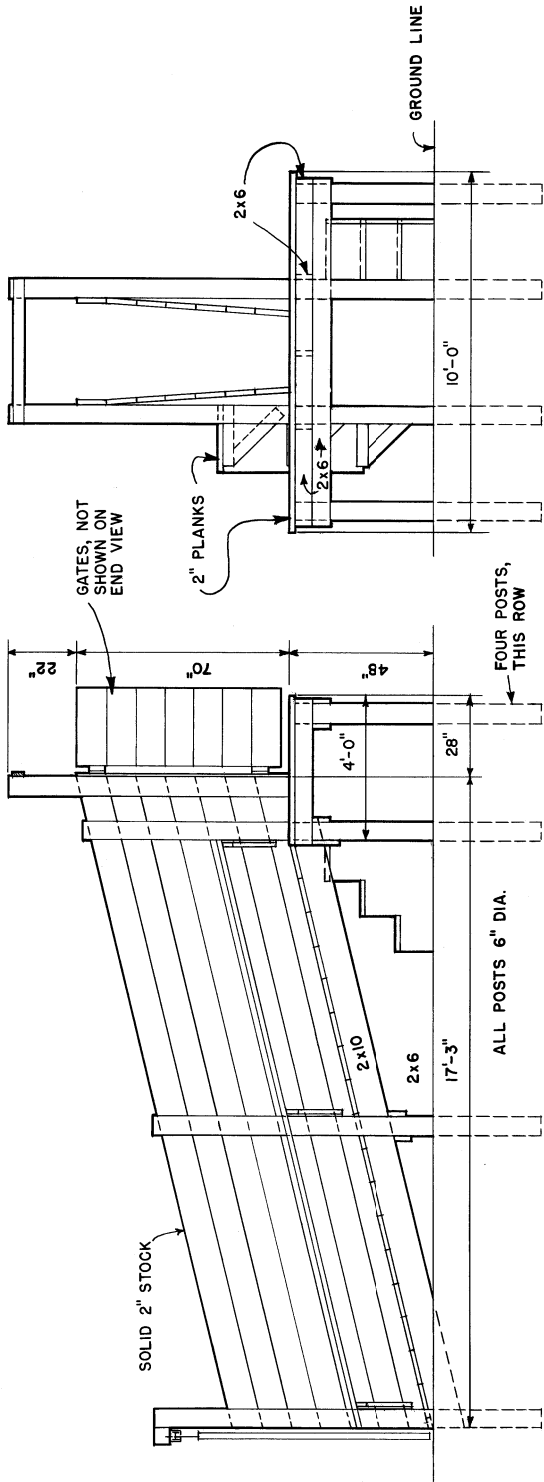

PLAN AT HINGE



SIDE VIEW

LOADING CHUTE

END VIEW

INSTALL CLEATS ON MAN AND ANIMAL RAMPS

AVOID PROJECTING BOLTS. USE TREATED POSTS.

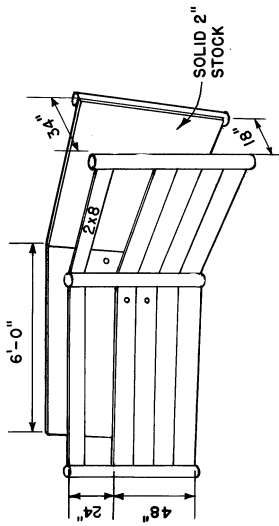

CHUTE SECTION

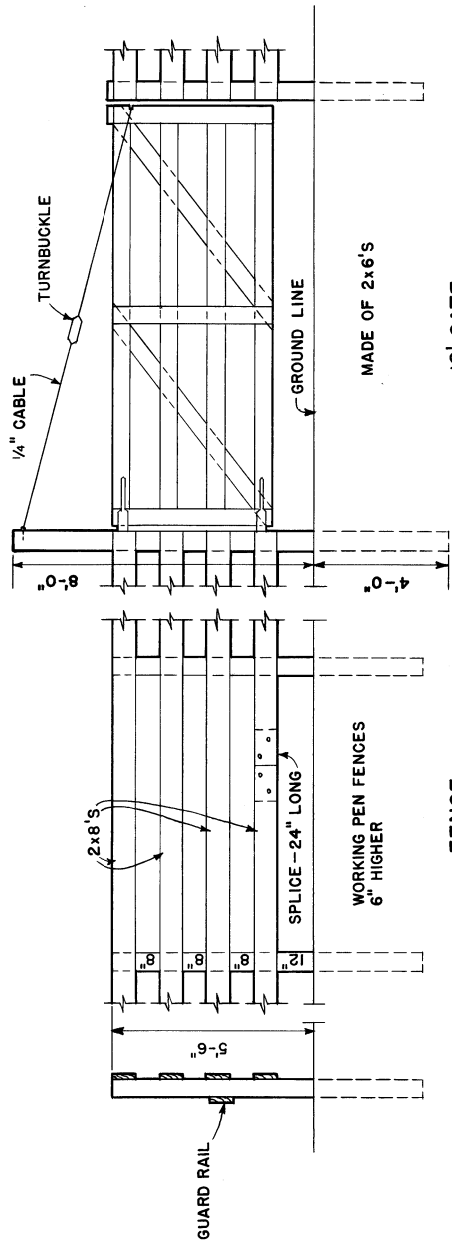

FENCE

12' GATE

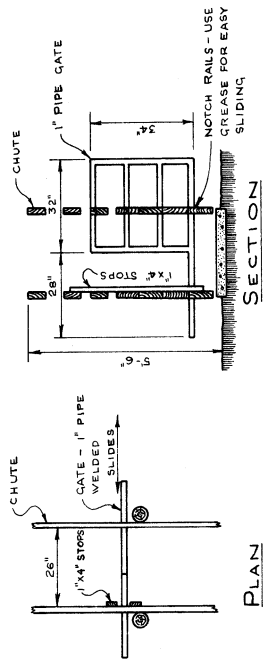
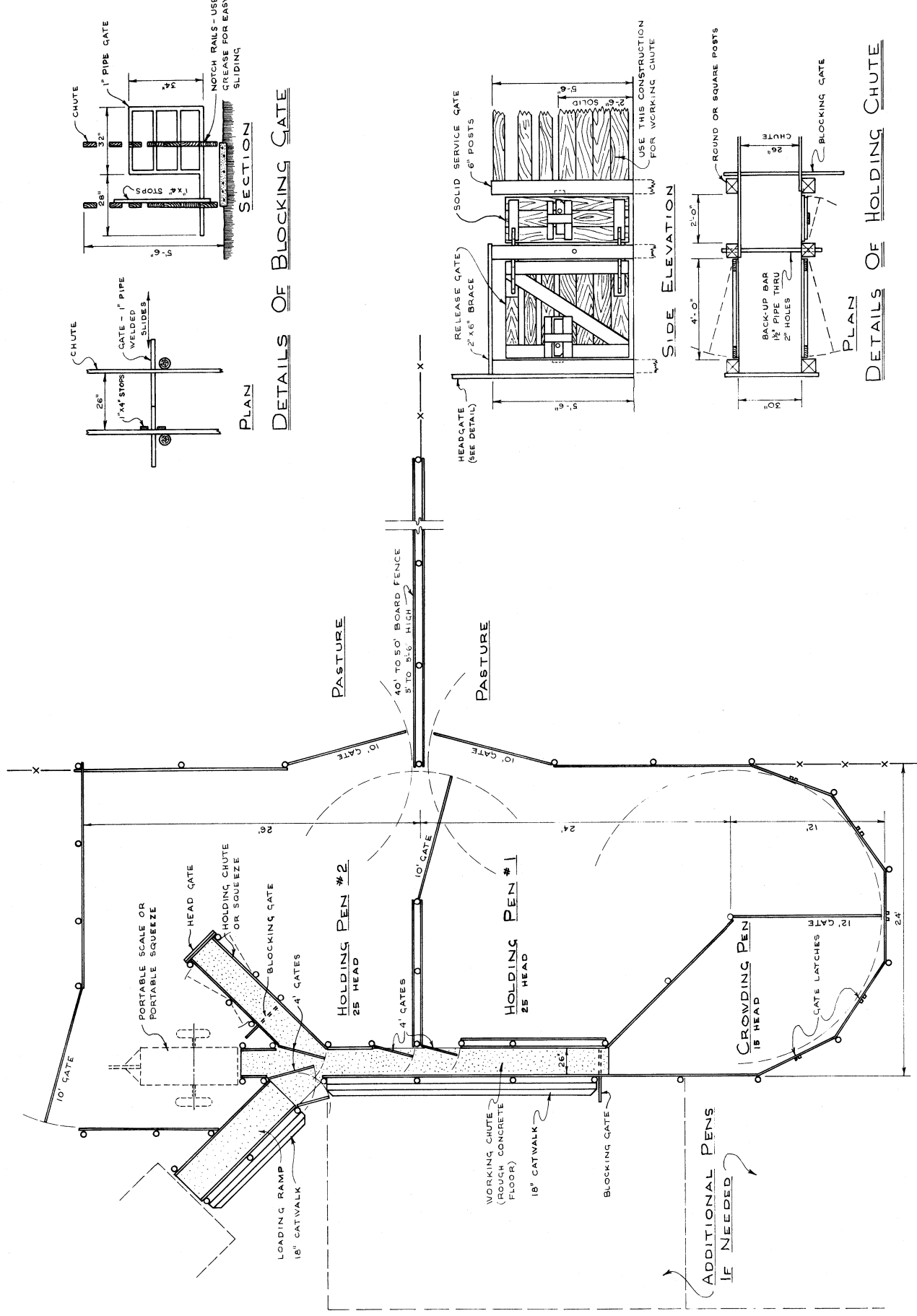

SECTION
DETAILS OF BLOCKING GATE

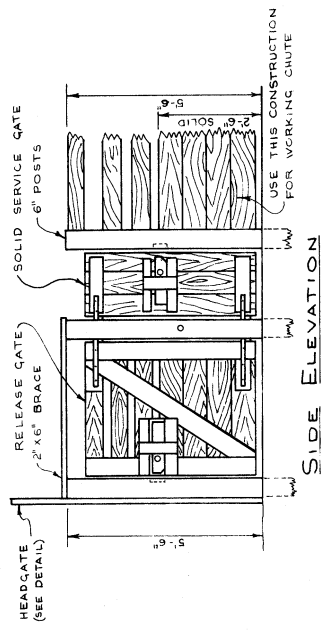

SIDE ELEVATION

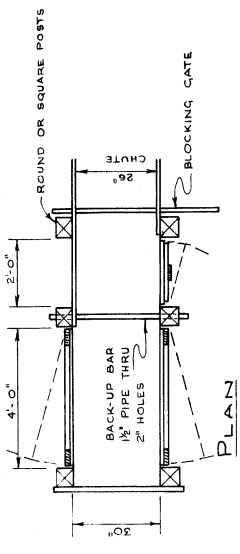

PLAN
DETAILS OF HOLDING CHUTE

PLAN

COOPERATIVE EXTENSION WORK IN
 AGRICULTURE AND HOME ECONOMICS
 STATE OF TENNESSEE
 UNIVERSITY OF TENNESSEE
 UNITED STATES DEPARTMENT OF AGRICULTURE COOPERATING

BEEF CATTLE CORRAL
 50 HEAD

N. C. '65 EX. 5991 SHEET 1 OF 2

NOTES:

1. THIS CORRAL HAS THE BASIC PARTS, PENS, WORKING CHUTE, HEADGATE, AND LOADING CHUTE NEEDED FOR HANDLING THE SMALL (25 - 30 HEAD) HERD.
2. GOOD WORKING FACILITIES WILL SAVE TIME, AVOID INJURY TO WORKERS AND CATTLE, AND MAKE TREATMENT, SORTING, WEIGHING, DEHORNING, ETC. AN EASIER CHORE.
3. LOCATE CORRAL ON WELL DRAINED SITE CONVENIENT TO LOTS AND ACCESSIBLE TO TRUCKS AND TRAILERS.
4. USE PRESSURE TREATED 2-INCH LUMBER FASTENED WITH BOLTS OR DEFORMED NAILS.
5. SPACE 5'-6" TOP, PRESSURE TREATED POSTS, 6' CENTER TO CENTER, UNLESS OTHERWISE NOTED.
6. SET GATE AND WORKING CHUTE POSTS IN CONCRETE OR BRACE OVERHEAD TO PREVENT SAGGING.

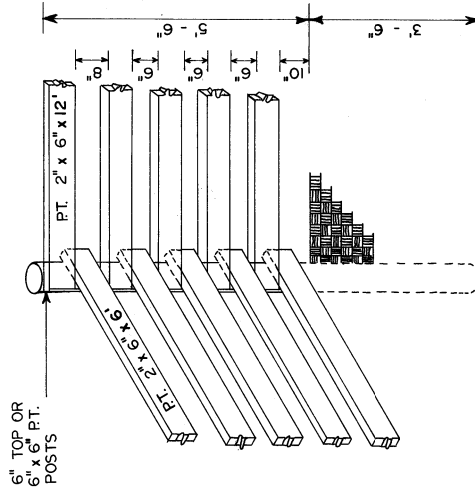
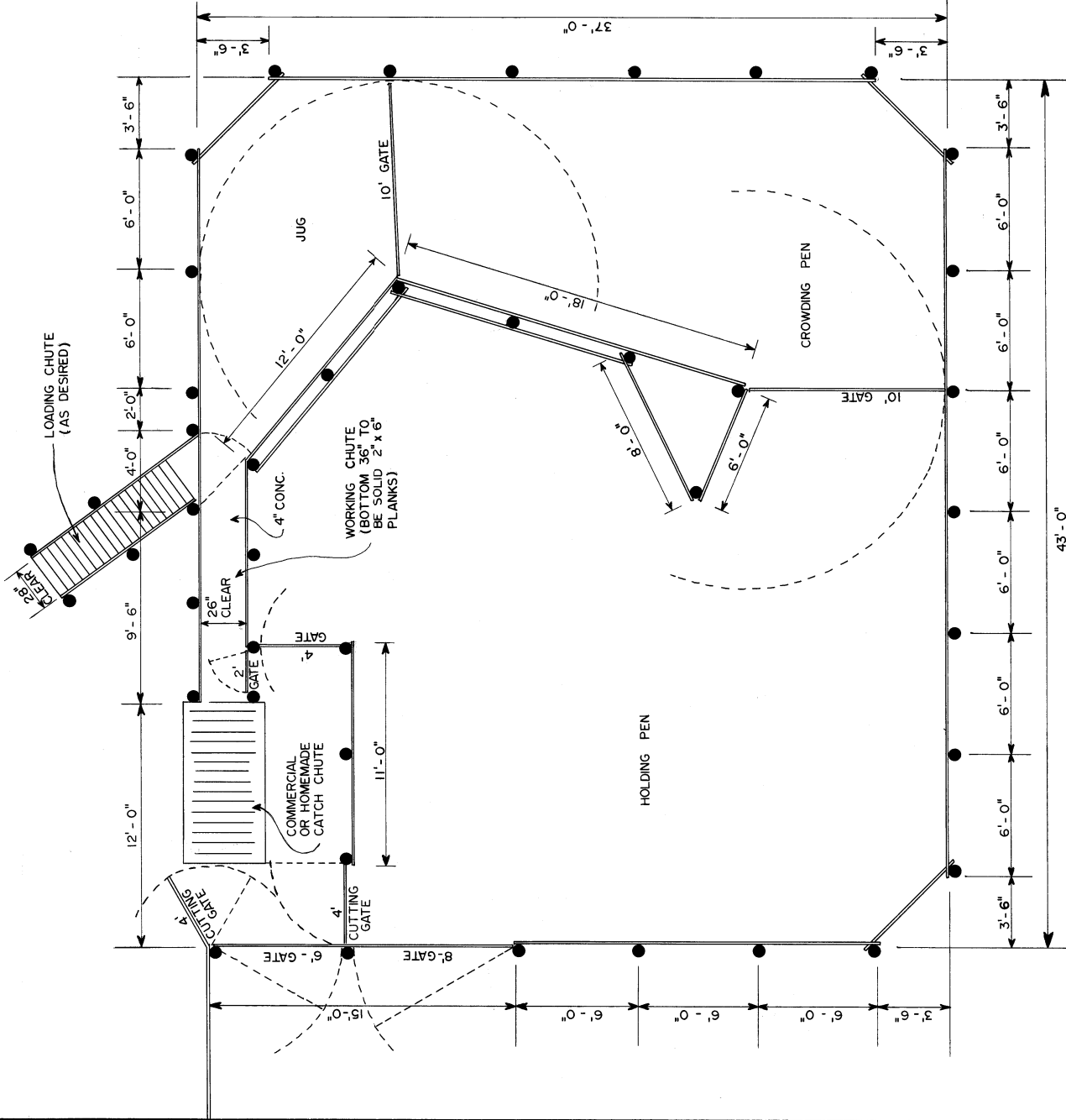

CORNER FENCING DETAIL

43'-0"

PLAN

COOPERATIVE EXTENSION WORK IN
 AGRICULTURE AND HOME ECONOMICS
 STATE OF TENNESSEE
 UNIVERSITY OF TENNESSEE
 AGRICULTURAL ENGINEERING DEPARTMENT
 UNITED STATES DEPARTMENT OF AGRICULTURE COOPERATING

TENNESSEE CORRAL

TENN / JYM / 12-3-84 / SHEET 1 OF 1
 GFG / JYM / PLAN NO. T4113

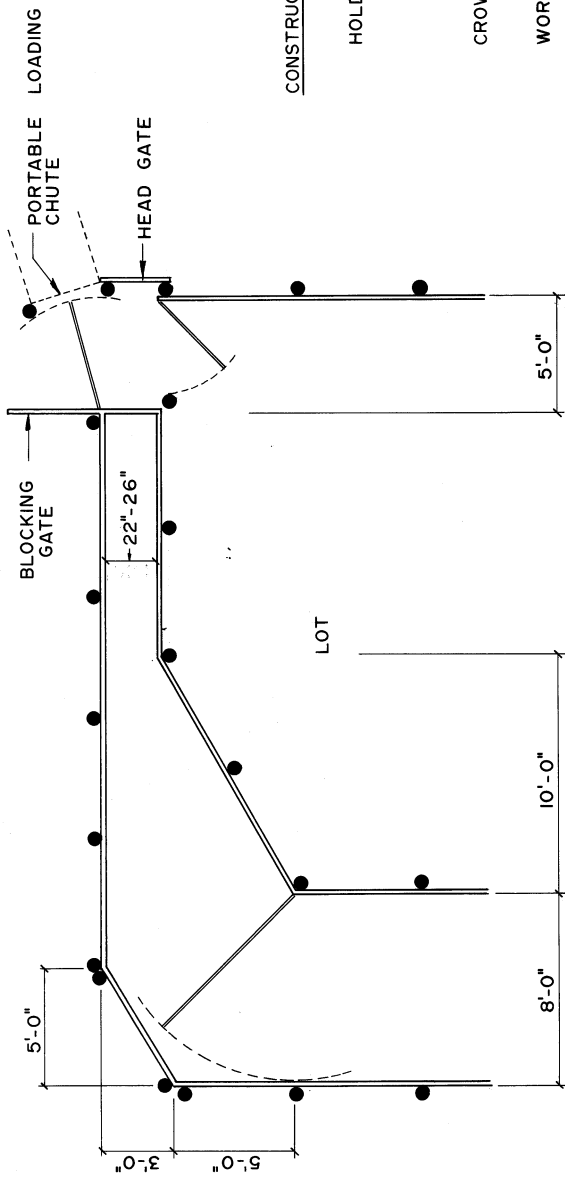

IN THE CORNER OF A FIELD

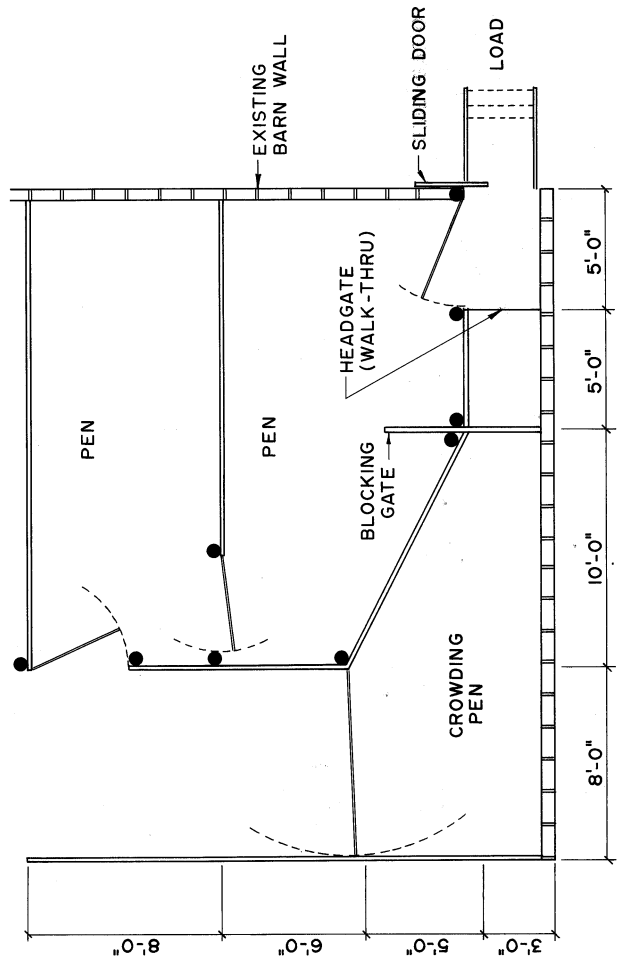

IN THE CORNER OF A BARN

CONSTRUCTION NOTES & SPECIFICATIONS

- HOLDING PENS:**
 20 SQ. FT. PER MATURE ANIMAL
 TWO (OR MORE) PENS
 WATER (IF CATTLE ARE HELD OVERNIGHT)
- CROWDING PEN:**
 150 SQ. FT. (ONE TRUCKLOAD)
- WORKING CHUTE:**
 18 TO 30 FT. LONG
 22" TO 26" WIDE
 BLOCKING GATES TO SPEED HANDLING & PREVENT CROWDING AT HEADGATE OR SCALES

- ADDITIONAL FEATURES:**
 PORTABLE SCALES
 SPRAY PEN
 CUTTING GATES FOR SORTING
 SQUEEZE
 WALKING PLATFORM ON ONE OR BOTH SIDES OF THE CHUTE

COOPERATIVE EXTENSION WORK IN AGRICULTURE AND HOME ECONOMICS
 STATE OF TENNESSEE
 UNIVERSITY OF TENNESSEE
 AGRICULTURAL ENGINEERING DEPARTMENT
 KIMBERLY W. HARRIS, ASSISTANT PROFESSOR
 UNITED STATES DEPARTMENT OF AGRICULTURE COOPERATING